



GENERAL SPECIFICATIONS

- PLUG: NEMA 5-15P USG
- OUTLET: IEC-60320-C13
- ★ • LENGTH: **6FT** ± 50
- WIRE TYPE: SJT 16AWG X3C 105°C
- JACKET: BLACK
- RATING: 10A/125V
- APPROVALS:  

PART TITLE	North American Power Cord (3 conductor) RoHS
-------------------	--

PART NO.	IEC-USG CORDSET-6FT
DATE	3.20.2015
APPROVAL	CB
UNIT	mm
REV	0

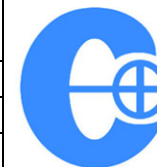



CONDOR ELECTRONICS, INC.
 T: 408-745-7141 F: 408-745-0439
 780 Montague Expy. Ste. 406
 San Jose, CA 95131 USA
sales@condorelectronics.net

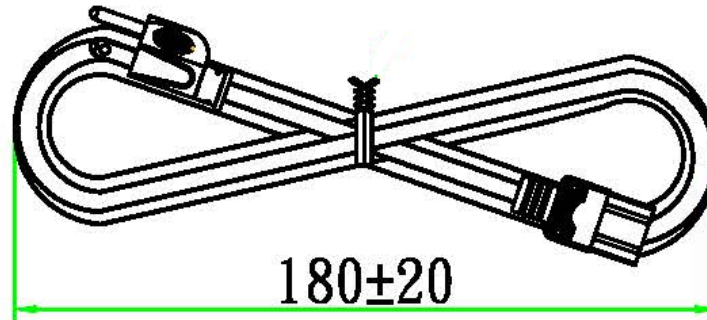
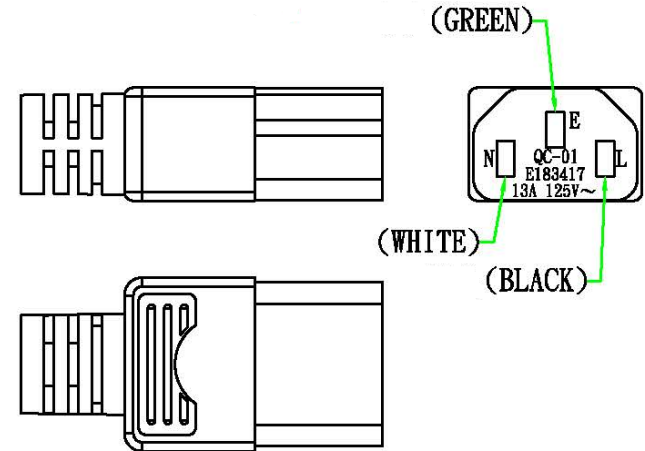
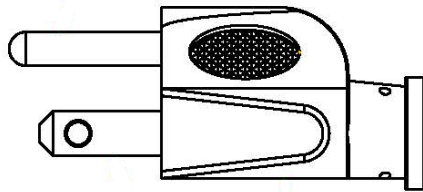
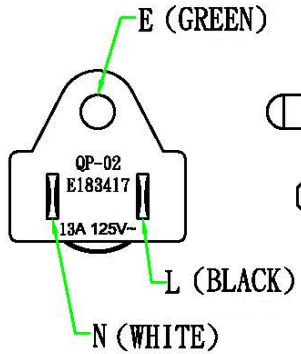
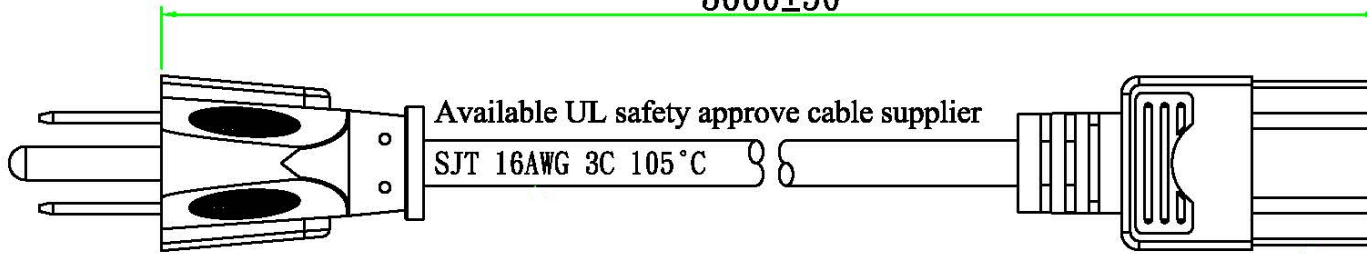

3660±50



GENERAL SPECIFICATIONS

- PLUG: NEMA 5-15P USG
- OUTLET: IEC-60320-C13
- ★ • LENGTH: 12FT ± 50
- WIRE TYPE: SJT 16AWG X3C 105°C
- JACKET: BLACK
- RATING: 10A/125V
- APPROVALS:  

PART TITLE	North American Power Cord (3 conductor) RoHS
-------------------	--

PART NO.	IEC-USG CORDSET-12FT
DATE	1.7.2015
APPROVAL	CB
UNIT	mm
REV	0

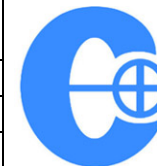

CONDOR ELECTRONICS, INC.
 T: 408-745-7141 F: 408-745-0439
 780 Montague Expy. Ste. 406
 San Jose, CA 95131 USA
sales@condorelectronics.net