

PIN DETAILS

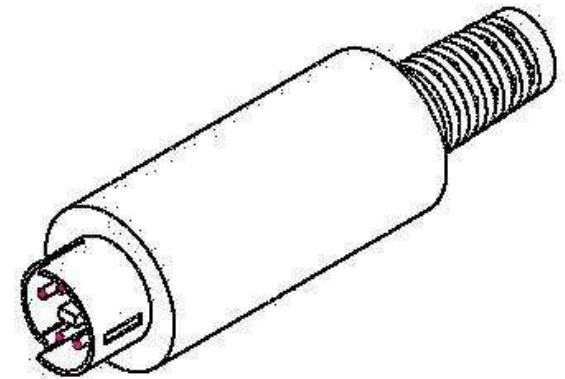

PART TITLE	Male 5 Pin Mini-Din
-------------------	---------------------

PART NO.	5MDIN
DATE	11.03.2015
APPROVAL	CB
UNIT	mm
REV	0

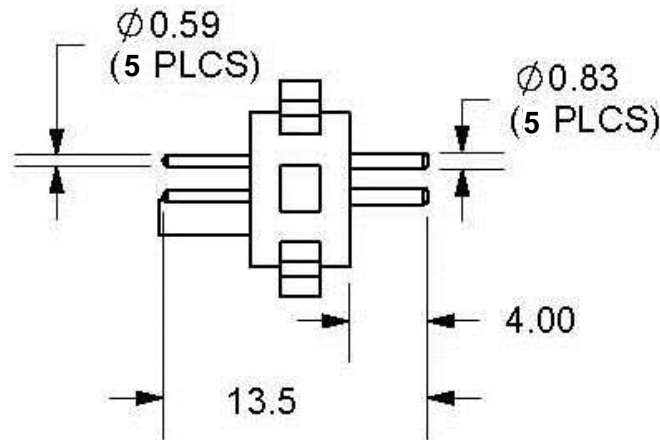

CONDOR ELECTRONICS, INC.
 T: 408-745-7141 F: 408-745-0439
 990 San Antonio Road
 Palo Alto, CA 94303 USA
sales@condorelectronics.net