

### PIN DETAILS

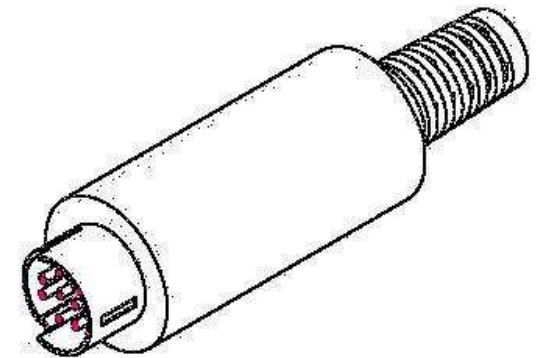

<b>PART TITLE</b>	Male 8 Pin Mini-Din
-------------------	---------------------

<b>PART NO.</b>	8MDIN
<b>DATE</b>	11.03.2015
<b>APPROVAL</b>	CB
<b>UNIT</b>	mm
<b>REV</b>	0

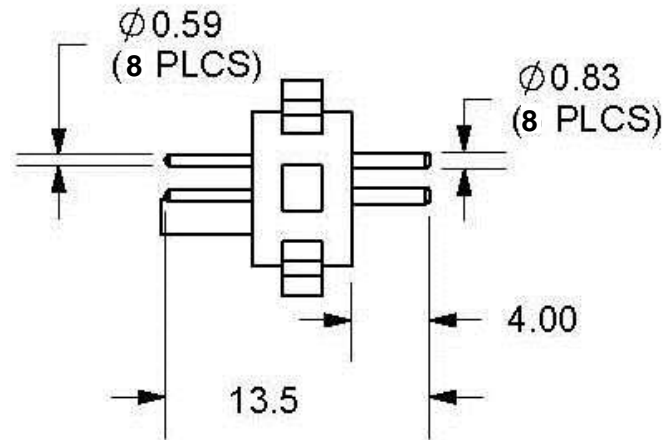
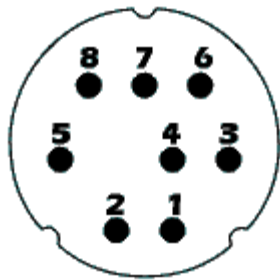

**CONDOR ELECTRONICS, INC.**  
 T: 408-745-7141 F: 408-745-0439  
 780 Montague Expy. Ste. 406  
 San Jose, CA 95131 USA  
[sales@condorelectronics.net](mailto:sales@condorelectronics.net)